

This article was downloaded by: [Purdue University]

On: 05 March 2013, At: 01:46

Publisher: Taylor & Francis

Informa Ltd Registered in England and Wales Registered Number: 1072954 Registered office: Mortimer House, 37-41 Mortimer Street, London W1T 3JH, UK



Molecular Crystals and Liquid Crystals Incorporating Nonlinear Optics

Publication details, including instructions for authors and subscription information:

<http://www.tandfonline.com/loi/gmcl17>

Temperature Dependence and Dispersion of the Rotatory Power of a Ferroelectric Liquid Crystal in the S_1^* Phase

J. Etxebarria^a, J. Zubia^a, A. Remón^a & M. J. Tello^a

^a Departamento de Física de la Materia Condensada, Departamento de Física Aplicada II, Facultad de Ciencias, Universidad del País Vasco, Apdo. 644, Bilbao, (Spain)
Version of record first published: 04 Oct 2006.

To cite this article: J. Etxebarria, J. Zubia, A. Remón & M. J. Tello (1989): Temperature Dependence and Dispersion of the Rotatory Power of a Ferroelectric Liquid Crystal in the S_1^* Phase, *Molecular Crystals and Liquid Crystals Incorporating Nonlinear Optics*, 177:1, 35-42

To link to this article: <http://dx.doi.org/10.1080/00268948908047768>

PLEASE SCROLL DOWN FOR ARTICLE

Full terms and conditions of use: <http://www.tandfonline.com/page/terms-and-conditions>

This article may be used for research, teaching, and private study purposes. Any substantial or systematic reproduction, redistribution, reselling, loan, sub-licensing, systematic supply, or distribution in any form to anyone is expressly forbidden.

The publisher does not give any warranty express or implied or make any representation that the contents will be complete or accurate or up to date. The accuracy of any instructions, formulae, and drug doses should be independently verified with primary sources. The publisher shall not be liable for any loss, actions, claims, proceedings, demand, or costs or damages whatsoever or howsoever caused arising directly or indirectly in connection with or arising out of the use of this material.

Temperature Dependence and Dispersion of the Rotatory Power of a Ferroelectric Liquid Crystal in the S_1^* Phase

J. ETXEBARRIA, J. ZUBIA,† A. REMÓN and M. J. TELLO

Departamento de Física de la Materia Condensada, †Departamento de Física Aplicada II, Facultad de Ciencias, Universidad del País Vasco, Apdo. 644, Bilbao (Spain)

(Received, February 16, 1989; in final form April 18, 1989)

High resolution rotatory power measurements have been carried out in the vicinity of the S_A - S_1^* phase transition of 1-ethoxycarbonylethyl (S)-4-(4'-decyloxy-2'-hydroxybenzylidene)aminocinnamate (DOHBAECEC). A remarkable rotatory dispersion has been observed in the visible range, together with a decrease in light transmission due to the selective reflection phenomenon. This effect has allowed us to measure the helical pitch in the S_1^* phase and, in conjunction with the optical activity, to obtain the temperature dependence of the tilt angle. This indirect method, which has been recently described in the literature, provides the tilt data on the unperturbed helicoidal phase and thus avoids the problems connected with the use of electric fields. The tilt results present a behaviour similar to the case of a S_A - S_C^* transition and can be accounted for within the framework of a mean-field model.

S_1^* phase, rotatory power measurements, selective reflection, tilt

1. INTRODUCTION

Ferroelectric liquid crystals have been the object of extensive investigation because, apart from their potential interest in some technical applications, they present some physical and chemical properties which make them attractive from the point of view of basic research. One of the most important parameters characterizing a ferroelectric mesophase is the tilt angle, which behaves like the order parameter at least for the most common transition leading to a ferroelectric mesophase, the S_A - S_C^* transition. Several optical methods have been developed for measuring this quantity,¹⁻⁴ but all suffer from the disadvantage of requiring the unwinding of the helical structure by a strong electric field. Consequently, in order to obtain the "spontaneous" tilt, it is necessary to extrapolate the results to the zero-field limit and the precise way in which this process should be carried out⁵ is not always clear.

Recently, Seppen *et al.*⁶ have shown how, by measuring the optical rotatory power and helical pitch for a S_C^* phase, one can obtain the tilt angle in an unperturbed sample. In this paper we use this procedure for studying the tilt behaviour in a S_1^* phase coming from a S_A phase. The chemistry of the compound, 1-ethoxy-

carbonylethyl (S)-4-(4'-decyloxy-2'-hydroxybenzylidene)aminocinnamate (DOHBAECEC), has been reported⁷ together with a preliminary characterization. The chemical structure is shown in Figure 1. The material undergoes the following phase sequence

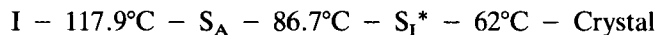

The study of the properties of this compound seemed to be interesting since there exist very few experimental results on any parameter near a S_A - S_I^* phase transition. Concerning the tilt angle, however, reliable measurements are difficult to perform because of a rather high electroclinic effect exhibited by the material near the ferroelectric transition.⁸ The magnitude of the induced tilt makes the above mentioned extrapolation problems specially difficult to solve and, therefore, the method proposed by Seppen *et al.* appears to be particularly suitable in this case.

We describe below the experimental techniques that were used for measurements of the optical activity and helical pitch. The results obtained and the tilt data arising from them are examined in Sec. 3.

2. EXPERIMENTAL

The sample cell was made of two glass plates coated with cetyltrimethylammonium bromide (CTAB) in order to obtain a homeotropic alignment in the S_A phase. The cell spacing was maintained by two teflon strips between the glass plates. The thickness was 280 μm , which is large enough to avoid surface effects.⁹ The cell was mounted in a Mettler hot stage, which allows the temperature to be stabilized within 0.1°C. The material was introduced into the cell by capillary action in the isotropic phase, and cooled through the transition to S_A and then down to the S_I^* phase at a rate 0.1°C/min. The quality of alignment was checked optically under the polarizing microscope. Both orthoscopic and conosopic observations confirmed a fairly good planar lamellar orientation¹⁰ over the whole sample area ($\approx 1 \text{ cm}^2$) at the S_A and S_I^* phases.

The experimental set-up for optical rotatory measurements is shown in Figure 2. Two light sources were alternatively employed: a 5 mW He-Ne laser or a 900 W Xe arc-lamp with a 0.25 m focal monochromator. The rotating analyser, which spins at about 25 Hz, had a two-hole chopper blade attached on its edge (not shown in the figure) in order to supply a reference signal to the lock-in amplifier. All the equipment was interfaced to a microcomputer for data acquisition.

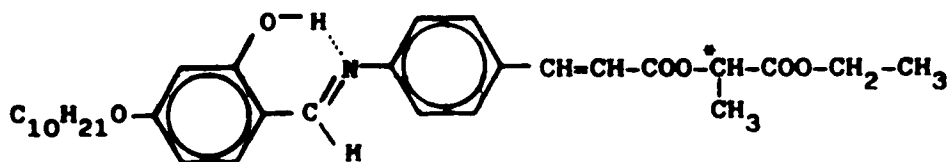

FIGURE 1 Chemical structure of DOHBAECEC.

The rotation of the light polarization after passing the sample was measured from the phase value of the signal at the photodiode. The rotation angle corresponding to the optical activity due to the S₁* helical structure is just half the phase angle relative to the (constant) output value at the S_A phase. Therefore, the method provides direct and continuous data for the rotatory power as a function of temperature.

The helical pitch for the S₁* phase was measured by using a variation of the selective reflection method. The same experimental arrangement shown in Figure 2 was used, but in this case the amplitude of the signal at the photodiode was recorded as a function of the wavelength for each temperature. The resulting curves were normalized with respect to the data for the S_A phase, in order to cancel the effect of the absorption bands of the material and account for the photodiode spectral response. The wavelength corresponding to the minimum is directly the product of the helical pitch and the average of the local refractive indices.¹¹⁻¹³

3. RESULTS AND DISCUSSION

Figure 3 shows the temperature dependence of the rotatory power in the S₁* phase of DOHBAECEC for a wavelength $\lambda = 633$ nm. The sign of the optical activity was taken as positive if the polarization plane rotated anticlockwise for light coming towards the observer. The measurements were performed at 0.1°C/min both on heating and cooling. No significant differences were found between them. As can be seen, the optical activity presents a maximum for $T_c - T = 9^\circ\text{C}$, which contrasts with the monotonous behaviour found for other ferroelectric liquid crystals in the

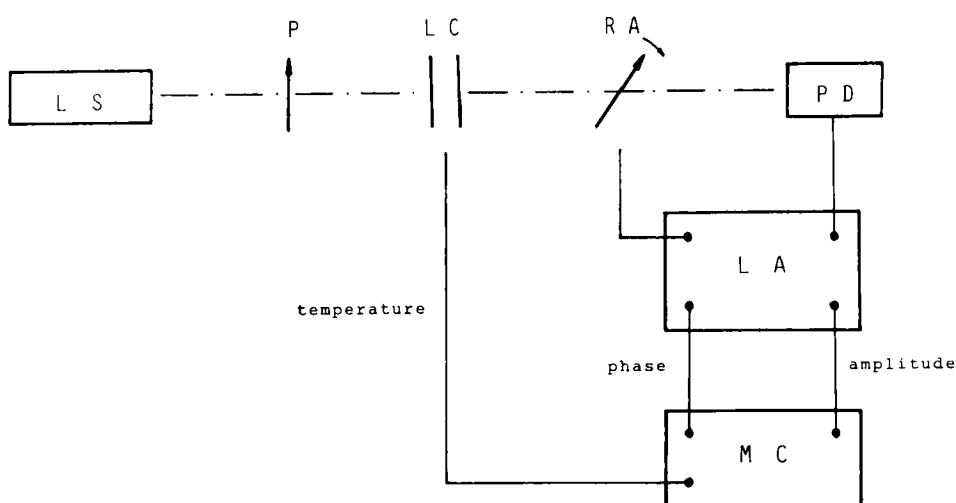

FIGURE 2 Block diagram of the equipment used for measuring the rotatory power. LS: light source, P: polarizer, LC: liquid crystal sample, RA: rotating analyser, PD: photodiode, LA: lock-in amplifier, MC: microcomputer.

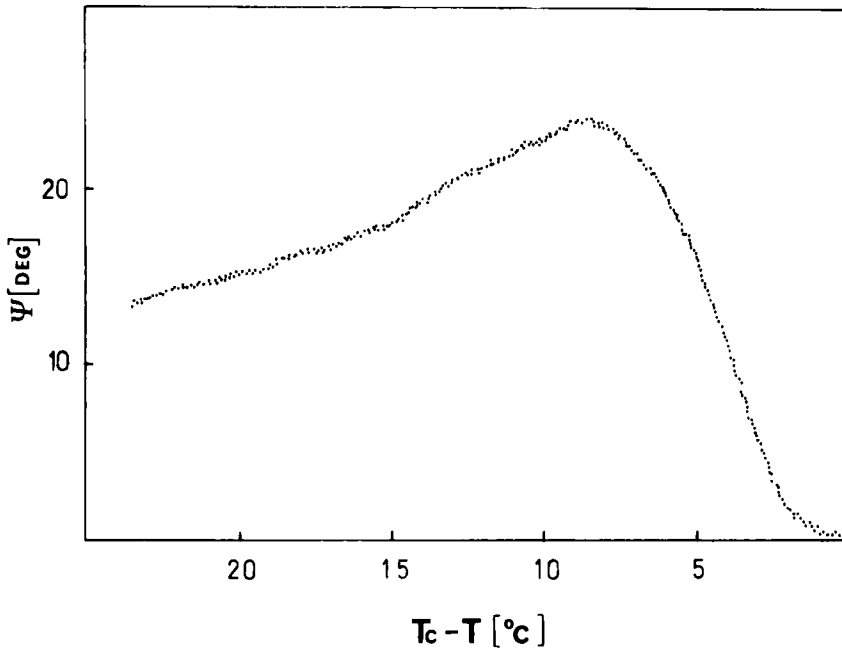

FIGURE 3 Rotation of the light polarization for a 280 μm sample of DOHBAECEC at $\lambda = 633 \text{ nm}$.

visible region.^{6,14,15} This anomalous temperature dependence is connected with a remarkable rotatory dispersion exhibited by the material in this spectral range. This can be proved by considering the theoretical approach of De Vries for the rotatory power in liquid crystal materials. It can be shown that in the case of tilted smectics, the rotation of the polarization of light propagating along the helical axis is given by^{6,12,16}

$$\frac{\Psi}{d} = - \frac{\pi p (\Delta n)^2 \sin^4 \theta}{4\lambda^2 \left[1 - \left(\frac{\lambda}{p\bar{n}} \right)^2 \right]} \quad (1)$$

where Ψ is the rotation angle, d the sample thickness, λ the vacuum wavelength, θ the tilt angle and p the helical pitch. \bar{n} and Δn are the average of the local refractive index and the birefringence respectively. Neglecting the small biaxiality of the ferroelectric mesophase, these quantities can be expressed as

$$\bar{n}^2 = \frac{n_o^2 [2n_e^2 - (n_e^2 - n_o^2) \sin^2 \theta]}{2[n_e^2 - (n_e^2 - n_o^2) \sin^2 \theta]}, \quad \Delta n = n_e - n_o \quad (2)$$

in terms of the refractive indices along (n_e) and perpendicular (n_o) to the director.

From Equation (1) it can be deduced that the temperature dependence of the optical rotation is largely determined by the temperature dependence and mag-

nitude of the helical pitch. If p is of the order λ/\bar{n} , Ψ is extremely sensitive to pitch variations, in such a way that the magnitude and even the sign of the optical activity are practically settled by the p value. That this is precisely our case can easily be proved by observation of the Airy spiral. For example, for $T_c - T < 15^\circ\text{C}$, opposite senses of the spiral rotation are found upon illumination with green and red light. This indicates a different sign in the optical activity, which can only be due to the fact that $p\bar{n}$ has an intermediate value between these two wavelengths.

Small dots in Figure 4 represent the rotatory power for $\lambda = 531$ nm. This curve confirms what has previously been discussed, and its shape is what one should expect according to Equation (1). We have not included any data near the singularity, because around the value $p = \lambda/\bar{n}$, the compound ceases to behave as a purely optically active material and presents strong reflection bands, and Equation (1) is no longer valid.^{12,16}

Figure 5 shows the temperature dependence of $p\bar{n}$. As can be seen, the results are in agreement with the behaviour obtained for the optical activity. In the narrow region near the transition point, measurements were difficult to perform because the dip minimum of the amplitude curves was very small. Nevertheless, we managed to make measurements as close as 0.2°C to the transition; this would have been rather difficult if the more usual transmittance technique^{11,13,17} had been used. This is due to the fact that the minimum in our amplitude curves is deeper than that for a typical transmission measurement, since the quantity we actually measure not only determines the amount of light passing through the sample, but also, for every

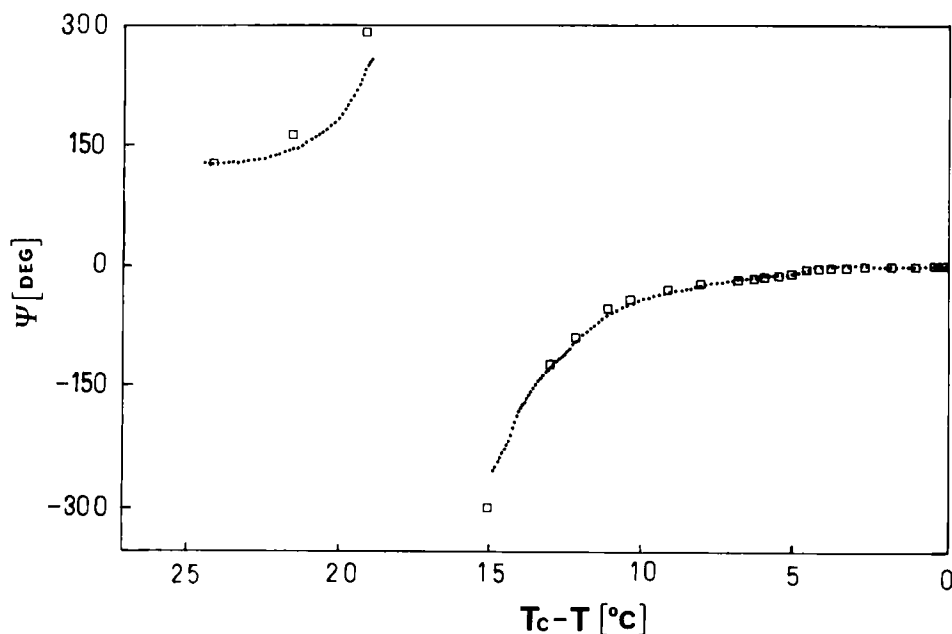

FIGURE 4 Small dots: experimental results for the rotatory power of DOHBAECEC at $\lambda = 531$ nm. Square symbols: calculated values from the θ data.

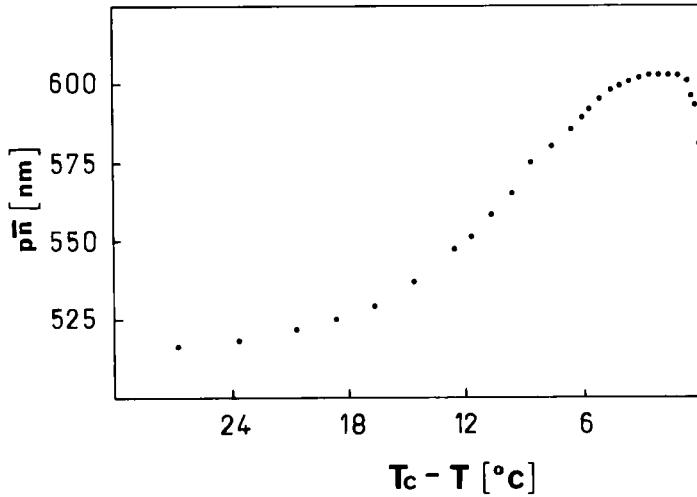

FIGURE 5 Temperature dependence of $p\bar{n}$ for the S_1^* phase of DOHBAECEC.

wavelength, its degree of deviation from the circular state of polarization. Figure 6 shows an example of our results for $T_c - T = 7^\circ\text{C}$.

We now turn to the tilt angle calculation from the above measurements. Figure 7 shows the behaviour of the θ values obtained. The data were extracted from the $p\bar{n}$ measurements and optical activity values for $\lambda = 633$ nm. The refractive indices were assumed to remain constant throughout the S_1^* phase, and their dependence on the wavelength (in the range 500–650 nm) was also neglected. Both assumptions

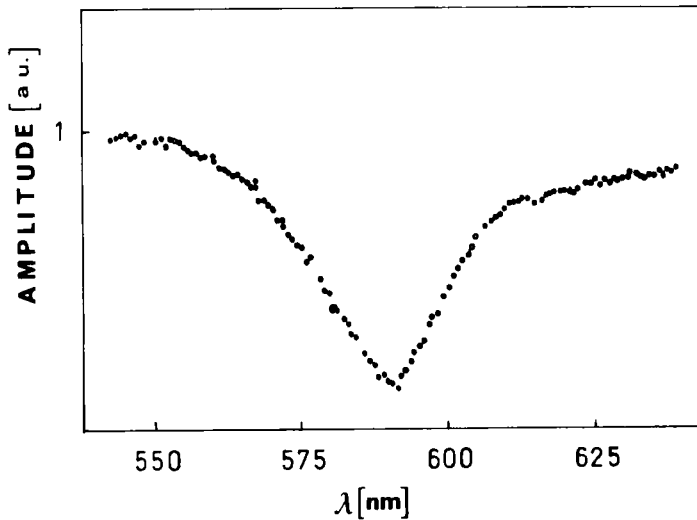

FIGURE 6 Wavelength dependence of the signal amplitude at $T_c - T = 7^\circ\text{C}$.

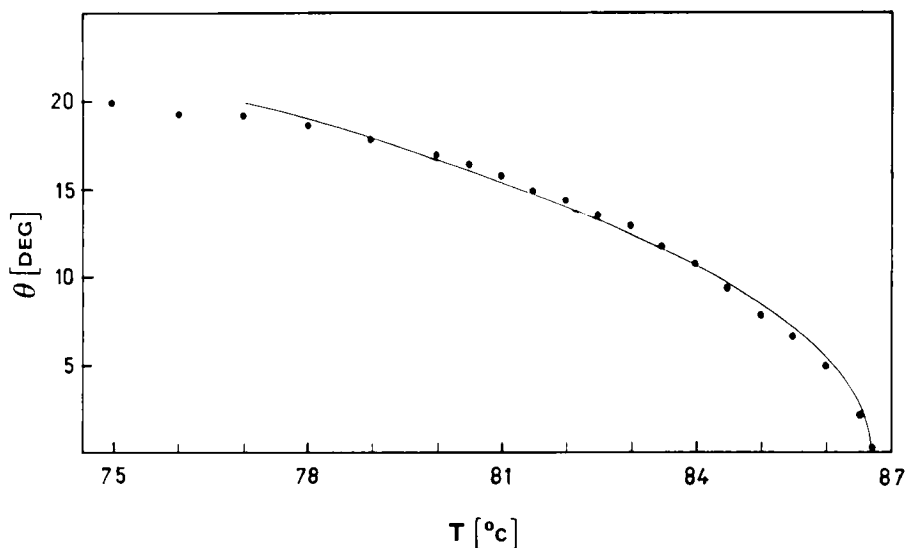

FIGURE 7 Temperature dependence of the tilt angle in the S₁* phase of DOHBAECEC.

are usually valid for ferroelectric mesophases within less than one percent,^{5,18} but we did check both points and confirmed the above hypothesis:

(i) We made a rough estimation of the average index \bar{n} by measuring an unaligned sample of the S₁* phase using an Abbé refractometer. The results showed no appreciable dependence on temperature and the dispersion was also very small (1.518 at 644 nm, 1.522 at 589 nm and 1.525 at 546 nm).

(ii) We calculated the optical activity at 531 nm from our θ results. The values obtained (shown by the square symbols in Figure 4) are in reasonable accordance with the actual measurements.

The tilt data were converted into absolute units from the θ results of Reference 8. Those measurements were performed using an unwound structure. Consequently, only the points far from the transition, where the ratio between the tilt induced by the electric field and its unperturbed value is very small, were used to calculate the scale factor.

The continuous line in Figure 7 is a least-squares fit of the tilt angle data to a power law $\theta = \theta_o (T_c - T)^\beta$. Taking the points down to 10°C below the transition point, the fitting parameters were determined to be $\theta_o = 6.48$ deg and $\beta = 0.5$. As can be seen, the function describes pretty well the observed behaviour over the fitting range. Although no comprehensive theory about the S_A-S₁* transition has been developed so far, it seems to be clear that the tilt angle should play the role of an order parameter in this transition. Our results indicate that the θ behaviour can be described in a similar fashion to the case of a S_A-S_C* transition. This is in agreement with other experimental results relating to spontaneous polarization, dielectric constants¹⁹ and soft-mode behaviour^{8,19} which can also be explained within

the framework of mean-field theories for the S_A - S_C * transition, without any reference to possible effects brought about by the in-plane S_I * ordering.

Finally, it is noted that DSC measurements showed a practically null change in enthalpy at the S_A - S_I * transition,⁷ suggesting the transition is second order. This would agree with the above facts, although it in no way constitutes definite proof of the character of the transition.

Acknowledgments

We are grateful to Dr. J. L. Serrano for providing the material. This work is supported in part by the CICYT of Spain and by the Research Funds of the Universidad del País Vasco (project no 063.310-0035188).

References

1. R. B. Meyer, L. Liebert, L. Strzelecki and P. Keller, *J. Phys. (Paris) Lett.*, **36**, L69 (1975).
2. Ph. Martinot-Lagarde, *J. Phys. (Paris)*, **37-C3**, 129 (1976).
3. G. Durand and Ph. Martinot-Lagarde, *Ferroelectrics*, **24**, 89 (1980).
4. J. Etxebarria, A. Remón, M. J. Tello, A. Ezcurra, M. A. Pérez Jubindo and T. Sierra, *Mol. Cryst. Liq. Cryst.*, **150 b**, 257 (1987).
5. H. Takezoe, K. Kondo, K. Miyasato, S. Abe, T. Tsuchiya, A. Fukuda and E. Kuze, *Ferroelectrics*, **58**, 55 (1984).
6. A. Seppen, I. Musevic, G. Maret, B. Zeks, P. Wyder and R. Blinc, *J. Phys. (Paris)*, **49**, 1569 (1988).
7. J. Barberá, E. Meléndez, J. L. Serrano and M. T. Sierra, *Ferroelectrics*, **85**, 405 (1988).
8. J. Etxebarria, A. Remón, M. J. Tello and J. L. Serrano, *Liq. Cryst.*, **4**, 543 (1989).
9. L. A. Beresnev, L. M. Blinov, M. A. Osipov and S. A. Pikin, *Mol. Cryst. Liq. Cryst.*, **158 A**, 3 (1988).
10. M. Brunet and N. Isaert, *Ferroelectrics*, **84**, 25 (1988).
11. H. Takezoe, K. Kondo, A. Fukuda and E. Kuze, *Jpn. J. Appl. Phys.*, **21**, L627 (1982).
12. I. Abdulhalim, L. Benguigui and R. Weil, *J. Phys. (Paris)*, **46**, 815 (1985).
13. I. Abdulhalim, L. Benguigui and R. Weil, *J. Phys. (Paris)*, **46**, 1429 (1985).
14. P. Pieranski, E. Guyon, P. Keller, L. Liebert, W. Kuczynski and P. Pieranski, *Mol. Cryst. Liq. Cryst.*, **38**, 275 (1977).
15. H. Takezoe, K. Furuhashi, T. Nakagiri, A. Fukuda and E. Kuze, *Jpn. J. Appl. Phys.*, **17**, 1219 (1978).
16. H. L. Ong, *Phys. Rev. A*, **37**, 3520 (1988).
17. S. A. Rozanski, *Phys. Stat. Sol (a)*, **79**, 309 (1983).
18. S. Garoff, PhD Thesis, Harvard University, Massachusetts (1977).
19. A. Ezcurra, M. A. Pérez Jubindo, J. Etxebarria, M. R. de la Fuente and M. T. Sierra, *Ferroelectrics* (in press).